

Trinkwasserspeicher für Wärmepumpe
Domestic hot water tank for heat pump
Ballon eau chaude sanitaire pour pompe à chaleur
Serbatoio di accumulo acqua calda sanitaria per pompa di calore
WPS/E 400 – 2000

Emailliert
 Enamelled | Émaillés | Smaltato

DIN

EN 12897
EnEV 730.02
ErP 812/2013
ErP 814/2013
DIN 4753

SVGW
SSIGE
1006-5752

CE

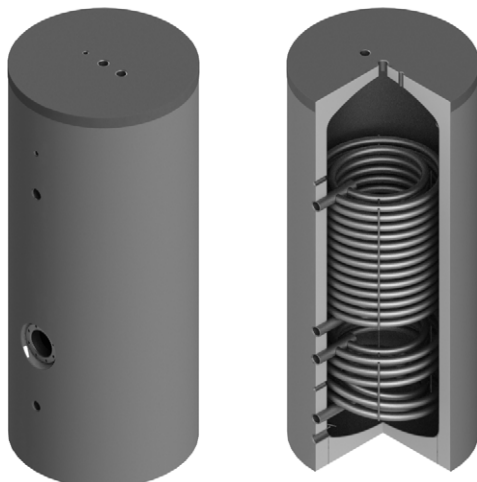

Bauart
Design | Structure | Struttura

Die Speicher werden aus hochwertigem Stahl nach EN 10025:2019 gefertigt.
 Die Speicher werden nach EN 12897:2020 dimensioniert, gefertigt und zertifiziert.

EN The storage tanks are made from high quality steel in accordance with EN 10025:2019.
 The storage tanks are designed, manufactured and certified in accordance with EN 12897:2020.

FR Les ballons sont fabriqués en acier de grande qualité selon la norme EN 10025:2019.
 Les ballons sont dimensionnés, fabriqués et certifiés selon la norme EN 12897:2020.

IT Gli accumulatori sono realizzati in acciaio pregiato secondo la norma EN 10025:2019.
 Gli accumulatori sono dimensionati, costruiti e certificati secondo la norma EN 12897:2020.

Betriebsdruck / Prüfdruck Operating pressure / test pressure Pression de service / Pression test Pressione d'esercizio / Pressione di collaudo	6 bar / 12 bar
Einsatzgebiet Application Application Applicazione	max. 95°C

Lieferumfang
Delivery | Livraison | Consegna

	l	mm		Art. Nr.
Betriebsanleitung Operation manual Mode d'emploi Istruzioni per l'uso			1 x	9001020001
Thermometer mit Tauchhülse Thermometer with immersion sleeve Thermomètre avec manchon d'immersion Termometro con manicotto ad immersione	≤ 600	100	1 x	6001150100
	≥ 800	200	1 x	6001150200
Tauchhülse Immersion sleeve Manchon d'immersion Manicotto ad immersione		1000	1 x	6001181011
Magnesium Schutzanode Magnesium protective anode Anode protectrice de magnésium Anodo protettivo in magnesio	400	520	1 x	6001140520
	500 – 600	520	1 x	6001140520
		1000	1 x	6001141000
	800 – 1000	1000	2 x	6001141000
	1250 – 1500	520	1 x	6001140520
		1000	2 x	6001141000
1750 – 2000	1000	3 x	6001141000	
Stellschrauben Adjusting screw Vis de réglage Viti di regolazione	800 – 2000	M12x25	3 x	6001990009

**Schutz vor Korrosion****Anti-corrosion protection | Protection contre la corrosion | Protezione anticorrosiva**

Doppelt gebrannte Zweischicht-Emallierung nach DIN 4753. Grosszügige Magnesium Schutzanode nach DIN 4753-3. Speicher mit separater Isolierung sind aussen mit einem Antikorrosionslack lackiert.

EN Dual-fired two-layer enamelling in accordance with DIN 4753. Generous magnesium protection anode in accordance with DIN 4753-3. Storage tanks with separate insulation are coated on the exterior with an anticorrosion paint.

FR Émaillage bi-couche à double cuisson conforme à la norme DIN 4753. Anode de protection de belle taille en magnésium conforme à la norme DIN 4753-3. Les réservoirs avec isolation séparée sont recouverts à l'extérieur d'une laque anticorrosion.

IT Smaltatura a doppia mano secondo DIN 4753. Anodo protettivo di magnesio in grande quantità secondo DIN 4753-3. Gli accumulatori con isolamento separato sono verniciati esternamente con smalto resistente alla corrosione.

Wärmetauscher**Heat exchanger | Échangeur de chaleur | Scambiatore di calore**

Zwei eingeschweisste grossflächige Wärmetauscher.

EN Two welded large-surface heat exchangers.

FR Deux échangeurs de chaleur grande surface soudés.

IT Due scambiatori di calore di grande superficie saldati.

Isolierung**Insulation | Isolation | Isolamento****PU-Hartschaum**

60 mm PU-Hartschaum fix geschäumt. Skaimantel 5 mm mit Reissverschluss vormontiert, inklusive Rosetten und Abdeckhaube. Brandschutzklasse B2. Silber. Weitere Farben nach Absprache.

UltraShell

Mehrschicht-Isolierung aus 80 mm Hartschaum + 20 mm Faservlies. PS-Mantel und Hakenleiste, inklusive Rosetten und Abdeckhaube. Brandschutzklasse B2. Silber. Lose geliefert.

EN Rigid polyurethane foam

60 mm rigid polyurethane foam. Skai jacket 5 mm with zip preassembled, including cover plates and hood. Fire-resistance rating B2. Silver. Other colours on request.

FR Mousse solidifiée PU

60 mm de mousse dure PU Enveloppe en skai de 5 mm préinstallée avec fermeture à glissière, y compris rosettes et capot. Classe allemande de protection incendie B2. Argent. Autres couleurs après concertation.

IT Schiuma PU rigida

60 mm di schiuma rigida di poliuretano fissa. Mantello in skai da 5 mm pre-assemblato con cerniera, dotato di rosette e calotta di copertura. Classe di resistenza antincendio B2. Argento. Altri colori su richiesta.

UltraShell

Multilayer insulation made of 80 mm rigid foam + 20 mm fibre fleece. PS jacket and hook rack, including cover plates and hood. Fire-resistance rating B2. Silver. Supplied loose.

UltraShell

Isolation multicouches constituée de 80 mm de mousse dure + 20 mm de tissu fibreux. Enveloppe en PS équipée d'un support à crochets préinstallé, y compris rosettes et capot. Classe allemande de protection incendie B2. Argent. Livrée non montée.

UltraShell

Isolamento multistrato con 80 mm di schiuma rigida + 20 mm di tessuto non tessuto. Mantello in PS e barra con ganci, rosette e calotta di copertura incluse. Classe di resistenza antincendio B2. Argento. Consegna sfusa.

≤ 600 L
PU-Hartschaum
B2; $\lambda = 0.026 \text{ W/(mK)}$

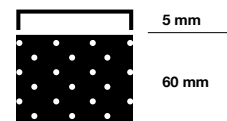

800 – 2000 L
UltraShell
B2; $\lambda = 0.0316 \text{ W/(mK)}$

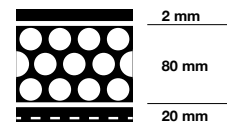

Trinkwasserspeicher für Wärmepumpe
Domestic hot water tank for heat pump
Ballon eau chaude sanitaire pour pompe à chaleur
Serbatoio di accumulo acqua calda sanitaria per pompa di calore
WPS/E 400 – 2000

Emailliert
Enamelled | Émaillés | Smaltato

Typ WPS/E		400	500	600	800	1000	1250	1500	1750	2000
Inhalt Capacity Contenance Contenuto	l	408	498	559	830	925	1226	1413	1728	1926
Ø mit Isolierung with insulation avec isolation con isolamento	mm	750	750	750	990	990	1100	1200	1300	1300
Ø ohne Isolierung without insulation sans isolation senza isolamento	mm	-	-	-	790	790	900	1000	1100	1100
Höhe mit Isolierung Height with insulation Hauteur avec isolation Altezza con isolamento	mm	1500	1800	2000	1990	2190	2240	2120	2150	2350
Kippmass Tilted dimension Cote de basculement Altezza in raddrizzamento	mm	1680	1950	2140	1990	2190	2260	2140	2200	2380
Betriebsdruck Heizung Heater operating pressure Pression de service du chauffage Pressione d'esercizio riscaldamento	bar	6	6	6	6	6	6	6	6	6
Betriebsdruck Wasser Water operating pressure Pression de service de l'eau Pressione d'esercizio acqua	bar	6	6	6	6	6	6	6	6	6
Prüfdruck Test pressure Pression test Pressione di collaudo	bar	12	12	12	12	12	12	12	12	12
max. Betriebstemperatur max. operating temperature Temp. de service max. Temperatura max. d'esercizio	°C	95	95	95	95	95	95	95	95	95
Gewicht Weight Poids Peso	kg	189	216	261	312	368	446	489	515	603
Art.Nr. Part no. Réf. Art.n.	100105...	0400	0500	0600	0800	1000	1250	1500	1750	2000
Isolierung Insulation Isolation Isolamento		60 mm fix eingeschäumt Fixed with foam Enrobage mousse fixe Schiuma rigida fissa			UltraShell 100					
Wärmeverlust Heat losses Pertesthermiques Perdita di calore	kWh/24h	1.69	1.95	2.05	3.29	3.45	3.64	3.84	4.05	4.42
	W	71	82	86	138	144	152	159	169	185
ErP-Klasse ErP class Classe ErP Classe ErP		B	B	B	C	C	C	C	C	C
Gewicht Weight Poids Peso	kg	-	-	-	35	40	45	50	55	60
Art.Nr. Part no. Réf. Art.n.	300105...	-	-	-	0809	1009	1259	1509	1759	2009



Typ WPS/E		400	500	600	800	1000	1250	1500	1750	2000
Glattrohrwärmetauscher unten Bottom heating coil Échangeurs de chaleur bas Serpentino inferiore	m ²	1.2	1.5	1.8	2.2	3.5	3.3	3.4	3.9	5.2
Inhalt Glattrohrwärmetauscher Heating coil capacity Contenance échangeurs de chaleur Contenuto serpentino	l	7.8	9.8	11.8	14.4	22.3	29.1	30.0	34.4	45.9
Durchflussmenge Throughput Débit Portata flusso	m ³ / h	1.5	1.9	2.3	2.8	4.4	4.2	4.3	4.9	6.6
Druckverlust Pressure loss Perte de charge Perdita di pressione	mbar	20	40	60	70	100	30	30	40	100
Dauerleistung Continuous output Régime permanent Potenza continua 10°C / 45°C / 80°C	l / h	435	543	652	796	1266	1194	1231	1410	1882
max. Glattrohrwärmetauscherleistung max. heating coil output Puissance max. du échangeurs de chaleur Potenza max. serpentino	kW	17.7	22.1	26.6	32.4	51.5	48.6	50.1	57.4	76.6
Typ WPS/E		400	500	600	800	1000	1250	1500	1750	2000
Glattrohrwärmetauscher oben Top heating coil Échangeurs de chaleur haut Serpentino superiore	m ²	2.9	3.8	5.3	5.2	6.0	7.7	7.3	7.8	9.1
Inhalt Glattrohrwärmetauscher Heating coil capacity Contenance échangeurs de chaleur Contenuto serpentino	l	18.4	24.1	34.7	34.0	39.2	67.9	64.4	68.8	80.2
Durchflussmenge Throughput Débit Portata flusso	m ³ / h	1.3	1.6	2.3	2.3	2.6	3.3	3.1	3.4	3.8
Druckverlust Pressure loss Perte de charge Perdita di pressione	mbar	20	20	30	30	30	30	30	30	30
Dauerleistung Continuous output Régime permanent Potenza continua 10°C / 45°C / 50°C	l / h	184	243	320	320	370	466	442	479	540
max. Glattrohrwärmetauscherleistung max. heating coil output Puissance max. du échangeurs de chaleur Potenza max. serpentino	kW	7.5	9.5	13.0	13.0	15.0	19.0	18.0	19.5	22.0
Durchflussmenge Throughput Débit Portata flusso	m ³ / h	3.7	4.8	6.7	6.5	7.6	9.8	9.3	9.9	11.5
Druckverlust Pressure loss Perte de charge Perdita di pressione	mbar	50	100	260	240	380	330	280	340	530
Dauerleistung Continuous output Régime permanent Potenza continua 10°C / 45°C / 80°C	l / h	1049	1377	2062	1881	2171	2786	2641	2823	3293
max. Glattrohrwärmetauscherleistung max. heating coil output Puissance max. d'échangeurs de chaleur Potenza max. serpentino	kW	42.6	56.0	78.0	76.6	88.4	113.4	107.5	114.9	134.0

Trinkwasserspeicher für Wärmepumpe
Domestic hot water tank for heat pump
Ballon eau chaude sanitaire pour pompe à chaleur
Serbatoio di accumulo acqua calda sanitaria per pompa di calore
WPS/E 400 – 2000

Emailliert
 Enamelled | Émaillés | Smaltato

400 – 600

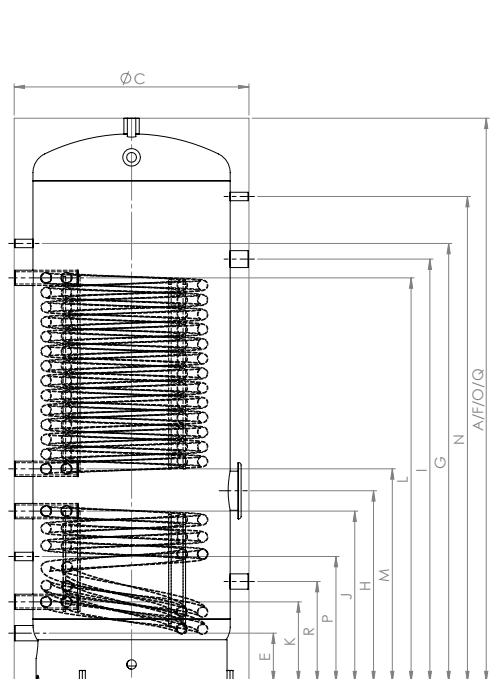

400 – 500

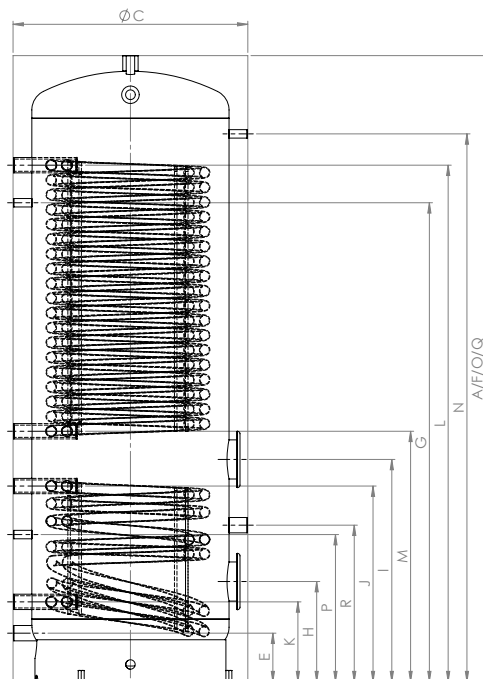

600

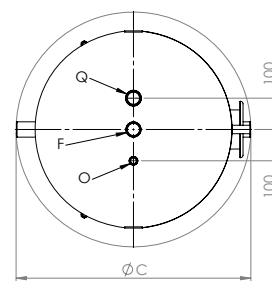

400 – 600



	Verwendung Usage Utilisation Uso	Dimension Dimension Dimension Dimensione	400	500	600
A	Höhe Height Hauteur Altezza	○ – mm	1500	1800	2000
C	Ø	○ – mm	750	750	750
E	Kaltwasser Cold water Eau froide Acqua fredda	⇕ – mm	155	155	155
		G"	1 ¼"	1 ¼"	1 ¼"
F	Warmwasser Hot water Eau chaude Acqua calda	⇕ – mm	1500	1800	2000
		G"	1 ¼"	1 ¼"	1 ¼"
G	Zirkulation Circulation Circulation Circolazione	⇕ – mm	1200	1400	1530
		G"	½"	½"	½"
H	Flansch unten Flange below Bride du bas Flangia inferiore	⇕ – mm	550	610	320
		Ø – mm	180/120	180/120	180/120
I	Flansch oben / Muffe E-Heizung Flange above / Sleeve heater Bride du haut / Manchon chauffage Flangia superiore / Manicotto riscaldatore	⇕ – mm	-	1350	710
		Ø – mm	-	1 ½"	180/120
J	VL Glattrohrwärmetauscher unten Bottom heating coil Échangeurs de chaleur bas Serpentino inferiore	⇕ – mm	490	545	625
		G"	1 ¼"	1 ¼"	1 ¼"
K	RL Glattrohrwärmetauscher unten Bottom heating coil Échangeurs de chaleur bas Serpentino inferiore	⇕ – mm	255	255	255
		G"	1 ¼"	1 ¼"	1 ¼"
L	VL Glattrohrwärmetauscher oben Top heating coil Échangeurs de chaleur haut Serpentino superiore	⇕ – mm	1115	1290	1650
		v – G"	1 ¼"	1 ¼"	1 ¼"
M	RL Glattrohrwärmetauscher oben Top heating coil Échangeurs de chaleur haut Serpentino superiore	⇕ – mm	620	680	800
		G"	1 ¼"	1 ¼"	1 ¼"
N	Thermometer Thermometer Thermomètre Termometro	⇕ – mm	1250	1550	1750
		G"	½"	½"	½"
O	Fühlerhülse Sensor sleeve Manchon de sonde Manicotto sensore	⇕ – mm	1500	1800	2000
		G"	½"	½"	½"
P	Fühler Sensor Sonde Sensor	⇕ – mm	400	400	470
		G"	½"	½"	½"
Q	Magnesiumanode Magnesium anode Anode de magnésium Anodo in magnesio	⇕ – mm	1500	1800	2000
		G"	1 ¼"	1 ¼"	1 ¼"
R	Magnesiumanode Magnesium anode Anode de magnésium Anodo in magnesio	⇕ – mm	320	320	500
		G"	1 ¼"	1 ¼"	1 ¼"

Trinkwasserspeicher für Wärmepumpe
Domestic hot water tank for heat pump
Ballon eau chaude sanitaire pour pompe à chaleur
Serbatoio di accumulo acqua calda sanitaria per pompa di calore
WPS/E 400 – 2000

Emailliert
 Enamelled | Émaillés | Smaltato

800 – 2000

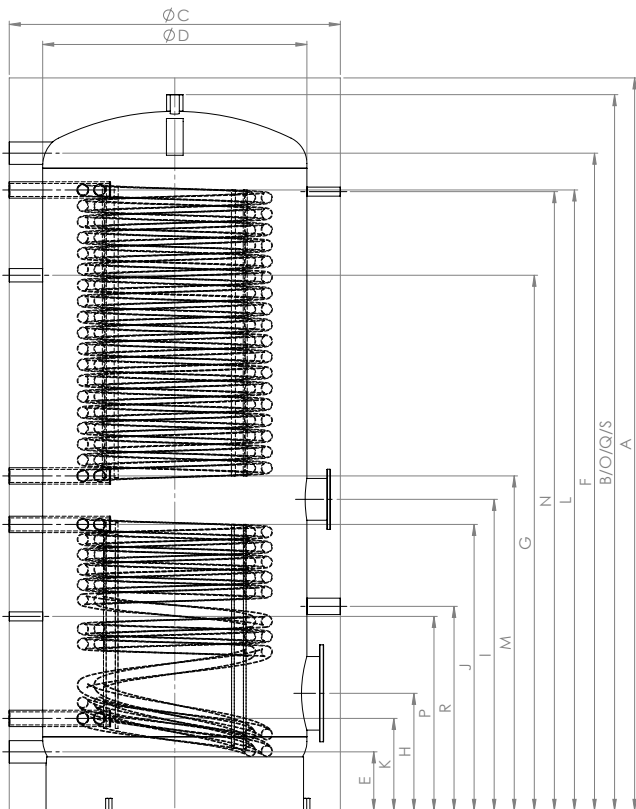

800 – 2000

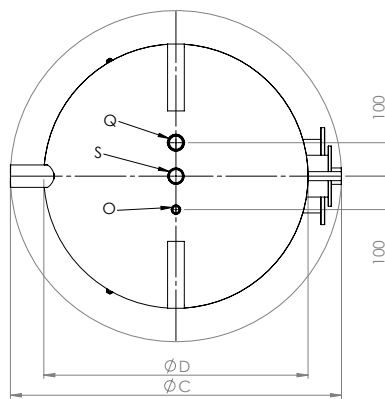

800 – 2000

- * ACHTUNG: Magnesium Schutzanode
- * ATTENTION Magnesium anode
- * ATTENTION Anode de magnésium
- * ATTENZIONE Anodo in magnesio



	Verwendung Usage Utilisation Uso	Dimension Dimension Dimension Dimensione	800	1000	1250	1500	1750	2000
A	Höhe Height Hauteur Altezza	○ – mm	1990	2190	2240	2120	2150	2350
B		○ – mm	1940	2140	2190	2070	2100	2300
C	Ø	● – mm	990	990	1100	1200	1300	1300
D		○ – mm	790	790	900	1000	1100	1100
E	Kaltwasser Cold water Eau froide Acqua fredda	⇕ – mm	175	175	200	220	235	235
		G" – mm	2"	2"	2"	2"	2"	2"
F	Warmwasser Hot water Eau chaude Acqua calda	⇕ – mm	1765	1965	1990	1730	1730	1930
		G" – mm	2"	2"	2"	2"	2"	2"
G	Zirkulation Circulation Circulation Circolazione	⇕ – mm	1400	1600	1600	1450	1400	1650
		G" – mm	1"	1"	1"	1"	1"	1"
H	Flansch unten Flange below Bride du bas Flangia inferiore	⇕ – mm	350	350	400	470	480	480
		Ø – mm	290/220	290/220	290/220	290/220	290/220	290/220
I	Flansch oben Flange above Bride du haut Flangia superiore	⇕ – mm	800	930	900	850	870	1000
		Ø – mm	180/120	180/120	180/120	180/120	180/120	180/120
J	VL Glatrohrwärmetauscher unten Bottom heating coil Échangeurs de chaleur bas Serpentino inferiore	⇕ – mm	675	855	790	780	780	900
		G" – mm	1 ¼"	1 ¼"	1 ½"	1 ½"	1 ½"	1 ½"
K	RL Glatrohrwärmetauscher unten Bottom heating coil Échangeurs de chaleur bas Serpentino inferiore	⇕ – mm	275	275	320	360	360	360
		G" – mm	1 ¼"	1 ¼"	1 ½"	1 ½"	1 ½"	1 ½"
L	VL Glatrohrwärmetauscher oben Top heating coil Échangeurs de chaleur haut Serpentino superiore	⇕ – mm	1620	1855	1870	1600	1590	1790
		G" – mm	1 ¼"	1 ¼"	1 ½"	1 ½"	1 ½"	1 ½"
M	RL Glatrohrwärmetauscher oben Top heating coil Échangeurs de chaleur haut Serpentino superiore	⇕ – mm	900	1000	1020	910	940	1090
		G" – mm	1 ¼"	1 ¼"	1 ½"	1 ½"	1 ½"	1 ½"
N	Thermometer Thermometer Thermomètre Termometro	⇕ – mm	1650	1850	1900	1750	1750	1950
		G" – mm	½"	½"	½"	½"	½"	½"
O	Fühlerhülse Sensor sleeve Manchon de sonde Manicotto sensore	⇕ – mm	1940	2140	2190	2070	2100	2300
		G" – mm	½"	½"	½"	½"	½"	½"
P	Fühler Sensor Sonde Sensor	⇕ – mm	540	580	660	590	600	600
		G" – mm	½"	½"	½"	½"	½"	½"
Q	Magnesiumanode Magnesium anode Anode de magnésium Anodo in magnesio	⇕ – mm	1940	2140	2190	2070	2100	2300
		G" – mm	1 ¼"	1 ¼"	1 ¼"	1 ¼"	1 ¼"	1 ¼"
R	Magnesiumanode Magnesium anode Anode de magnésium Anodo in magnesio	⇕ – mm	570	610	670	1080	1110	730
		G" – mm	1 ¼"	1 ¼"	1 ¼"	1 ¼"	1 ¼"	1 ¼"
S	Anschluss oben Connection top Lien ci-dessus Collegamento sopra	⇕ – mm	1940	2140	2190*	2070*	2100*	2300*
		G" – mm	1 ¼"	1 ¼"	1 ¼"	1 ¼"	1 ¼"	1 ¼"